



UA

Front Surround System

YAS-106

Owner's Manual

EN

IMPORTANT SAFETY INSTRUCTIONS



CAUTION
RISK OF ELECTRIC SHOCK
DO NOT OPEN



CAUTION: TO REDUCE THE RISK OF ELECTRIC SHOCK, DO NOT REMOVE COVER (OR BACK). NO USER-SERVICEABLE PARTS INSIDE. REFER SERVICING TO QUALIFIED SERVICE PERSONNEL.

Explanation of Graphical Symbols

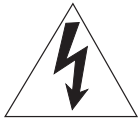

The lightning flash with arrowhead symbol within an equilateral triangle is intended to alert you to the presence of uninsulated “dangerous voltage” within the product’s enclosure that may be of sufficient magnitude to constitute a risk of electric shock to persons.



The exclamation point within an equilateral triangle is intended to alert you to the presence of important operating and maintenance (servicing) instructions in the literature accompanying the appliance.

IMPORTANT

Please record the serial number of this unit in the space below.

MODEL:

Serial No.:

The serial number is located on the rear of the unit. Retain this Owner’s Manual in a safe place for future reference.

FOR CANADIAN CUSTOMERS

To prevent electric shock, match wide blade of plug to wide slot and fully insert.

CAN ICES-3 (B)/NMB-3 (B)

- 1 Read these instructions.
- 2 Keep these instructions.
- 3 Heed all warnings.
- 4 Follow all instructions.
- 5 Do not use this apparatus near water.
- 6 Clean only with dry cloth.
- 7 Do not block any ventilation openings. Install in accordance with the manufacturer’s instructions.
- 8 Do not install near any heat sources such as radiators, heat registers, stoves, or other apparatus (including amplifiers) that produce heat.
- 9 Do not defeat the safety purpose of the polarized or grounding-type plug. A polarized plug has two blades with one wider than the other. A grounding type plug has two blades and a third grounding prong. The wide blade or the third prong are provided for your safety. If the provided plug does not fit into your outlet, consult an electrician for replacement of the obsolete outlet.
- 10 Protect the power cord from being walked on or pinched particularly at plugs, convenience receptacles, and the point where they exit from the apparatus.
- 11 Only use attachments/accessories specified by the manufacturer.
- 12 Use only with the cart, stand, tripod, bracket, or table specified by the manufacturer, or sold with the apparatus. When a cart is used, use caution when moving the cart/apparatus combination to avoid injury from tip-over.
- 13 Unplug this apparatus during lightning storms or when unused for long periods of time.
- 14 Refer all servicing to qualified service personnel. Servicing is required when the apparatus has been damaged in any way, such as power-supply cord or plug is damaged, liquid has been spilled or objects have fallen into the apparatus, the apparatus has been exposed to rain or moisture, does not operate normally, or has been dropped.



We Want You Listening For A Lifetime



Yamaha and the Electronic Industries Association’s Consumer Electronics Group want you to get the most out of your equipment by playing it at a safe level. One that lets the sound come through loud and clear without annoying blaring or distortion – and, most importantly, without affecting your sensitive hearing. Since hearing damage from loud sounds is often undetectable until it is too late, Yamaha and the Electronic Industries Association’s Consumer Electronics Group recommend you to avoid prolonged exposure from excessive volume levels.

FCC INFORMATION (for US customers)

- | | |
|--|--|
| 1 IMPORTANT NOTICE: DO NOT MODIFY THIS UNIT! This product, when installed as indicated in the instructions contained in this manual, meets FCC requirements. Modifications not expressly approved by Yamaha may void your authority, granted by the FCC, to use the product. | 4 Compliance with FCC regulations does not guarantee that interference will not occur in all installations. If this product is found to be the source of interference, which can be determined by turning the unit “OFF” and “ON”, please try to eliminate the problem by using one of the following measures: |
| 2 IMPORTANT: When connecting this product to accessories and/or another product use only high quality shielded cables. Cable/s supplied with this product MUST be used. Follow all installation instructions. Failure to follow instructions could void your FCC authorization to use this product in the USA. | 5 Relocate either this product or the device that is being affected by the interference. |
| 3 NOTE: This product has been tested and found to comply with the requirements listed in FCC Regulations, Part 15 for Class “B” digital devices. Compliance with these requirements provides a reasonable level of assurance that your use of this product in a residential environment will not result in harmful interference with other electronic devices. This equipment generates/uses radio frequencies and, if not installed and used according to the instructions found in the users manual, may cause interference harmful to the operation of other electronic devices. | 6 Utilize power outlets that are on different branch (circuit breaker or fuse) circuits or install AC line filter/s. |
| | 7 In the case of radio or TV interference, relocate/reorient the antenna. If the antenna lead-in is 300 ohm ribbon lead, change the lead-in to coaxial type cable. |
| | 8 If these corrective measures do not produce satisfactory results, please contact the local retailer authorized to distribute this type of product. If you can not locate the appropriate retailer, please contact Yamaha Corporation of America A/V Division 6600 Orangethorpe Ave., Buena Park, CA 90620. |
| | 9 The above statements apply ONLY to those products distributed by Yamaha Corporation of America or its subsidiaries. |

This device complies with Part 15 of FCC Rules and Industry Canada license-exempt RSS standard(s). Operation is subject to the following two conditions: (1) this device may not cause interference, and (2) this device must accept any interference, including interference that may cause undesired operation of this device.

FCC CAUTION

Changes or modifications not expressly approved by the party responsible for compliance could void the user’s authority to operate the equipment.

NOTICE

- This equipment complies with FCC/IC radiation exposure limits set forth for an uncontrolled environment and meets the FCC radio frequency (RF) Exposure Guidelines and RSS-102 of the IC radio frequency (RF) Exposure rules. This equipment has very low levels of RF energy that it deemed to comply without maximum permissive exposure evaluation (MPE). But it is desirable that it should be installed and operated with at least 20 cm and more between the radiator and person’s body.
- This transmitter must not be co-located or operated in conjunction with any other antenna or transmitter.

CAUTION: READ THIS BEFORE OPERATING YOUR UNIT.

- To assure the finest performance, please read this manual carefully. Keep it in a safe place for future reference.
- Install this unit in a well ventilated, cool, dry, clean place - away from direct sunlight, heat sources, vibration, dust, moisture, and/or cold. For proper ventilation, allow the following minimum clearances.
Top: 10 cm (4 in), Rear: 10 cm (4 in), Sides: 10 cm (4 in)
- Locate this unit away from other electrical appliances, motors, or transformers to avoid humming sounds.
- Do not expose this unit to sudden temperature changes from cold to hot, and do not locate this unit in an environment with high humidity (i.e. a room with a humidifier) to prevent condensation inside this unit, which may cause an electrical shock, fire, damage to this unit, and/or personal injury.
- Avoid installing this unit where foreign objects may fall onto this unit and/or this unit may be exposed to liquid dripping or splashing. On the top of this unit, do not place:
 - Other components, as they may cause damage and/or discoloration on the surface of this unit.
 - Burning objects (i.e. candles), as they may cause fire, damage to this unit, and/or personal injury.
 - Containers with liquid in them, as they may fall and liquid may cause electrical shock to the user and/or damage to this unit.
- Do not cover this unit with a newspaper, tablecloth, curtain, etc., in order not to obstruct heat radiation. If the temperature inside this unit rises, it may cause fire, damage to this unit, and/or personal injury.
- Do not plug in this unit to a wall outlet until all connections are complete.
- Do not operate this unit upside-down. It may overheat, possibly causing damage.
- Do not use force on switches, knobs and/or cords.
- When disconnecting the power cable from the wall outlet, grasp the plug; do not pull the cable.
- Do not clean this unit with chemical solvents; this might damage the finish. Use a clean, dry cloth.
- Only voltage specified on this unit must be used. Using this unit with a higher voltage than specified is dangerous and may cause fire, damage to this unit, and/or personal injury. Yamaha will not be held responsible for any damage resulting from use of this unit with a voltage other than specified.
- To prevent damage by lightning, keep the power cable and outdoor antennas disconnected from a wall outlet or the unit during a lightning storm.
- Do not attempt to modify or fix this unit. Contact qualified Yamaha service personnel when any service is needed. The cabinet should never be opened for any reasons.

- When not planning to use this unit for long periods of time (i.e. vacation), disconnect the AC power plug from the wall outlet.
- Be sure to read the “Troubleshooting” section on common operating errors before concluding that this unit is faulty.
- Before moving this unit, press  to set this unit in standby mode, and disconnect the power supply cable from the wall outlet.
- Condensation will form when the surrounding temperature changes suddenly. Disconnect the power supply cable from the outlet, then leave the unit alone.
- Install this unit near the wall outlet and where the AC power plug can be reached easily.
- Secure placement or installation is the owner’s responsibility. Yamaha shall not be liable for any accident caused by improper placement or installation of speakers.
- Keep the product out of reach of children to avoid them swallowing small parts.

Notes on remote controls and batteries

- Do not spill water or other liquids on the remote control.
- Do not drop the remote control.
- Do not leave or store the remote control in the following places:
 - places of high humidity, such as near a bath
 - places of high temperatures, such as near a heater or a stove
 - places of extremely low temperatures
 - dusty places
- Do not expose the remote control sensor of this unit to direct sunlight or lighting such as inverted fluorescent lamps.
- If the batteries grow old, the effective operation range of the remote control decreases considerably. If this happens, replace the batteries with two new ones as soon as possible.
- Exhausted batteries may leak. If the batteries have leaked, dispose of them immediately. Avoid touching the leaked material or letting it come into contact with clothing, etc. Clean the battery compartment thoroughly before installing new batteries.
- Do not carry batteries in a pocket or purse with metal objects like coins, etc.
- Do not throw away batteries with general house waste. Dispose of them correctly in accordance with your local regulations.
- Keep batteries away from children. If a battery is accidentally swallowed, contact your doctor immediately.

- When not planning to use the remote control for long periods of time, remove the batteries from the remote control.
- Do not charge or disassemble the supplied batteries.
- The batteries shall not be exposed to excessive heat such as sunshine, fire or like.

Radio waves may affect electro-medical devices.
Do not use this unit near medical devices or inside medical facilities.

The name plate is located on the bottom of the unit.



WARNING

DO NOT INGEST BATTERY, CHEMICAL BURN HAZARD



CAUTION

Replace only with the same type or equivalent type.
Risk of explosion if battery is incorrectly replaced.

The remote control supplied with this product contains a coin/button cell battery. If the coin/button cell battery is swallowed, it can cause severe internal burns in just 2 hours and can lead to death.

Keep new and used batteries away from children. If the battery compartment does not close securely, stop using the product and keep it away from children.

If you think batteries might have been swallowed or placed inside any part of the body, seek immediate medical attention.

WARNING

TO REDUCE THE RISK OF FIRE OR ELECTRIC SHOCK, DO NOT EXPOSE THIS UNIT TO RAIN OR MOISTURE.

As long as this unit is connected to the AC wall outlet, it is not disconnected from the AC power source even if you turn off this unit by . In this state, this unit is designed to consume a very small quantity of power.

 **(Power key)**

Turns on the power of this unit or sets it to the standby mode.

Do not use this unit within 22 cm (9 inches) of persons with a heart pacemaker implant or defibrillator implant.

Contents

IMPORTANT SAFETY INSTRUCTIONS	2
CAUTION: READ THIS BEFORE OPERATING YOUR UNIT.....	4
Supplied items	7
Features	10
Frequently asked questions.....	11
Part names and functions	12
The unit (front panel/top panel).....	12
The unit (rear panel).....	13
Installation	14
Installing the unit on a TV stand, etc.....	14
Mounting the unit on a wall.....	14
Connections	16
Operations.....	19
Operating the unit by TV's remote control (HDMI control).....	22
Listening to the sound from a Bluetooth device.....	23

Settings	26
Configuring the HDMI control function.....	26
Configuring HDMI audio output	26
Enabling/disabling the auto power standby function	27
Initializing the unit.....	27
Troubleshooting.....	28
Specifications	33

About this manual

NOTE

This indicates precautions for use of the product and its feature limitations.

HINT

This indicates supplementary explanations for better use.

Supplied items

Make sure you have received all of the following items.



The unit



Remote control

A CR2025 Lithium battery has already been inserted into the remote control.

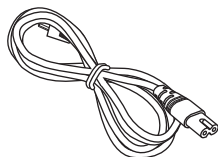

Power cable



Optical digital audio cable



Spacers x 2

Use when mounting the unit on a wall

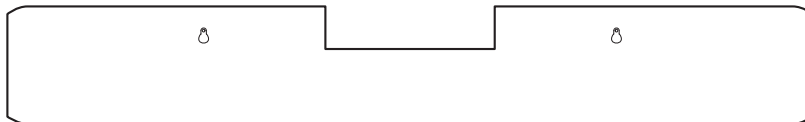

Mounting template

Use when mounting the unit on a wall



Owner's Manual (this booklet)

Preparing the remote control

Remove the battery's insulating strip before attempting to use the remote control.

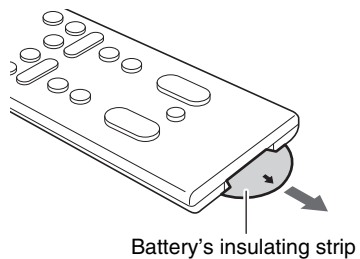

Operating range of the remote control

Operate the remote control within the range as shown below. When the unit is mounted on a wall, point the remote control at the remote control sensor on the top panel (p. 14).

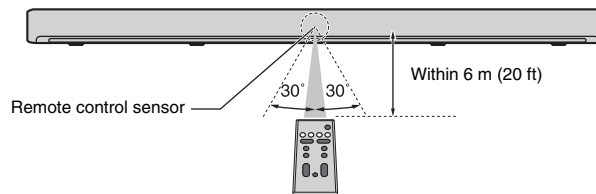

Replacing the battery in the remote control

Press and hold the release tab in the direction indicated by (A), and slide the battery holder out in the direction indicated by (B).

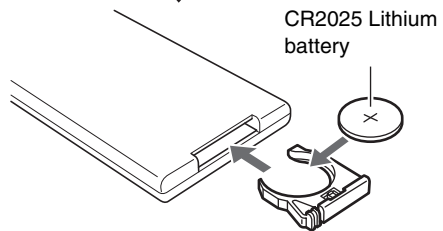
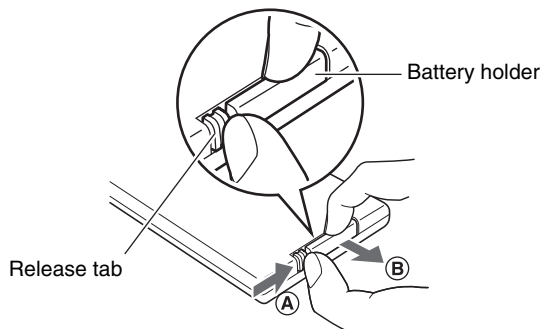

Features

This front surround system is easily installed and has a built-in subwoofer for enjoying powerful and realistic sound with connection to a TV or other devices.

- **Transmission of 4K high dynamic range (HDR) video supported**

Enjoy high-resolution video from a cable or satellite set top box, or a BD/DVD player. When a TV that supports Audio Return Channel (ARC) is used, this ARC-compatible unit can be connected to the TV via a single HDMI cable (p. 16).

- **HDMI control function**

Link TV and unit functions using the TV's remote control (p. 22).

- **Bluetooth connection**  **Bluetooth®**

Easily play content from a *Bluetooth*-compatible smartphone, tablet, or computer (p. 23).

Our exclusive Compressed Music Enhancer technology improves sound quality and characteristics, and can be used to enjoy realistic and impressive sound.

- **HOME THEATER CONTROLLER app** 

HOME THEATER CONTROLLER, a free app for smartphones, allows you to easily operate the unit using a smartphone (p. 25).

- **Bass extension**

Boost low bass levels to enjoy more powerful sound (p. 20).

- **Clear voice**

This feature makes speech, such as dialog and narration, clearer (p. 20).

Frequently asked questions

The following section covers popular functions and frequently asked questions about the unit.

Q1 Can I use the TV's remote control to operate the unit?

A1 Yes. When the unit is connected to a TV via HDMI cable, the TV's remote control can be used to operate both the TV and the unit (p. 22).

Q2 Can I improve the clarity of dialogue?

A2 Yes. Dialogue in movies, TV news, sports programs, etc., can be made clearer using the "clear voice" function (p. 20).

Q3 Can I use a smartphone to operate the unit? Can I use a smartphone to turn the unit on or off?

A3 Yes. The unit can be operated with a smartphone using the free app, HOME THEATER CONTROLLER, installed on the smartphone (p. 25).
In addition, the *Bluetooth* standby function can be used to turn on the unit when a *Bluetooth* connection between the unit and the smartphone is established, and to turn off the unit when that connection is terminated (p. 25).

Q4 Can the brightness of the indicators be adjusted?

A4 Yes. Use the DIMMER key on the remote control (p. 21).

Q5 How can surround playback be enabled?

A5 Press the SURROUND key on the remote control (p. 20).

Q6 Can the subwoofer's volume be adjusted?

A6 Yes. Use the SUBWOOFER (+/-) keys on the remote control (p. 21).

Part names and functions

The unit (front panel/top panel)

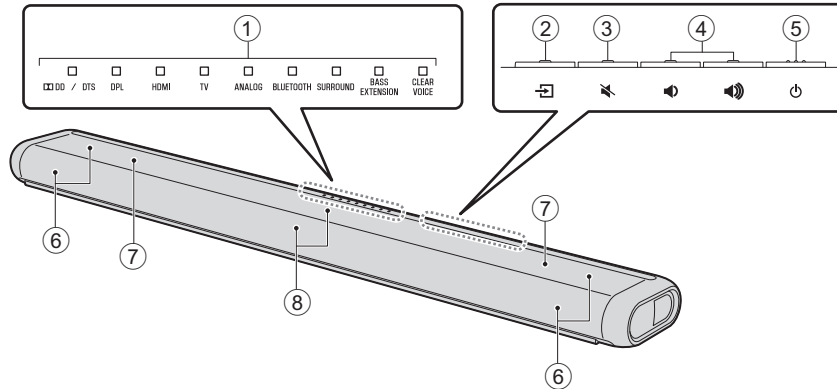

① Indicators

The indicators on the top panel flash or glow, to show the operation and setting status. In this manual, illustrations of the nine in-line indicators are used for explanation as necessary.

□ : Off ■ : Glows ☀ : Flashes

Example: When the DPL and SURROUND indicators glow, and the HDMI indicator flashes



② (input) key

Select an input source to be played back (p. 19).

③ (mute) key

Mute the audio output. Press the key again to unmute (p. 21).

④ (volume +/-) keys

Adjust the volume (p. 21).

⑤ (power) key

Turn on or off the unit (p. 19).

HINT

- The unit may automatically turn off when the auto power standby function is enabled (p. 27).

⑥ Speakers

⑦ Dual built-in subwoofers

The built-in subwoofers are located in the top part of the unit.

⑧ Remote control sensors

Receive infrared signals from the remote control of the unit (p. 8).

The unit (rear panel)

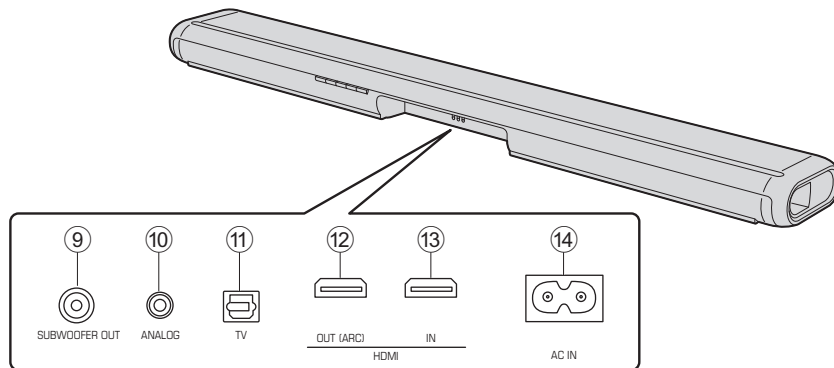

⑨ SUBWOOFER OUT jack

For connecting to an external subwoofer with an RCA mono cable (p. 18).

⑩ ANALOG input jack

For connecting to an external device with a 3.5 mm stereo mini plug cable (p. 17).

⑪ TV input jack

For connecting to a TV with an optical digital audio cable (p. 16).

⑫ HDMI OUT (ARC) jack

For connecting to an HDMI-compatible TV (p. 16).

⑬ HDMI IN jack

For connecting an HDMI-compatible playback device such as a BD/DVD player, a satellite and cable TV tuner, and a game console (p. 16).

⑭ AC IN jack

Connect the power cable of this unit (p. 18).

Installation

The unit can be installed on a TV stand or mounted on a wall.

Installing the unit on a TV stand, etc.

Position the unit so that the keys are on the far side of the unit.

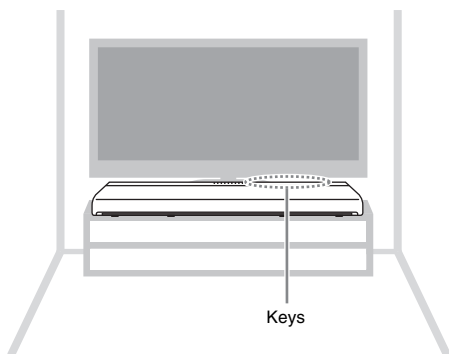

Cautions

- Do not stack the unit and a BD player or other device directly on each other. Doing so may cause a malfunction due to vibrations.
- Do not hold the speaker portion (fabric parts) on the front and the top of the unit.
- The unit contains non-magnetic shielding speakers. Do not place magnetically sensitive items (hard disk drive, etc.) near the unit.
- Depending on your installation environment, it may be better to connect the unit and external devices before installing the unit.

Mounting the unit on a wall

Refer to “How to mount the unit on the wall” (p. 15) for instructions on mounting the unit on a wall so that the keys face upwards.

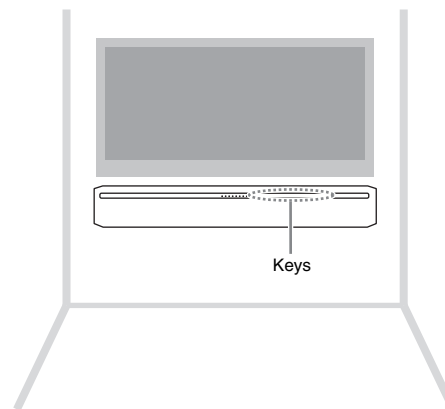

How to mount the unit on the wall

Cautions

- When mounting the unit on a wall, all installation work must be performed by a qualified contractor or dealer. The customer must never attempt to perform this installation work. Improper or inadequate installation could cause the unit to fall, resulting in personal injury.
- To prevent the unit from falling, attach it to a wall constructed of drywall (plasterboard).
- Make sure you use commercially available screws that can support the weight of the installation (specified in Step 2 on the right). Using clamps other than specified screws, such as short screws, nails, and two-sided tape, may cause the unit to fall.
- Fix the cables in place where they will not become loose. If your foot or hand accidentally gets caught on a loose cable, the unit may fall.
- Do not lean on the unit or apply excessive force to the top of the unit. Doing so may cause the unit to fall.
- Check that the unit is fixed securely after the installation. Yamaha will bear no responsibility for any accidents caused by improper installations.

1 Attach the mounting template on a wall and mark for the screw holes.

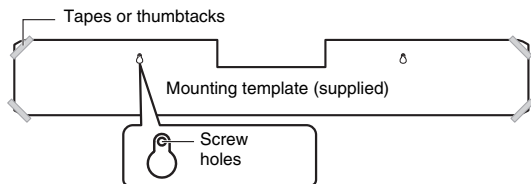

2 Remove the mounting template from the wall, then install commercially available screws (as illustrated below) at the points marked on the wall.

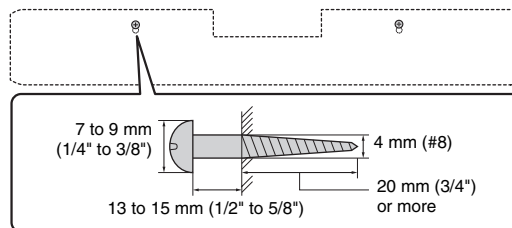

3 Peel off the backing paper from the spacers and attach the adhesive face to the unit as illustrated below.

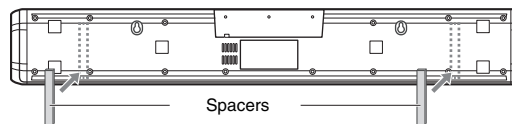

4 Hang the unit on the screws.

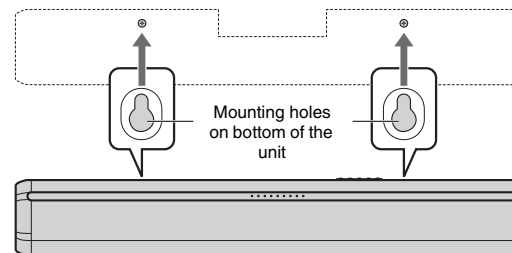

Connections

1 Connecting a TV and set-top box

For the cable connection, follow the procedure below.

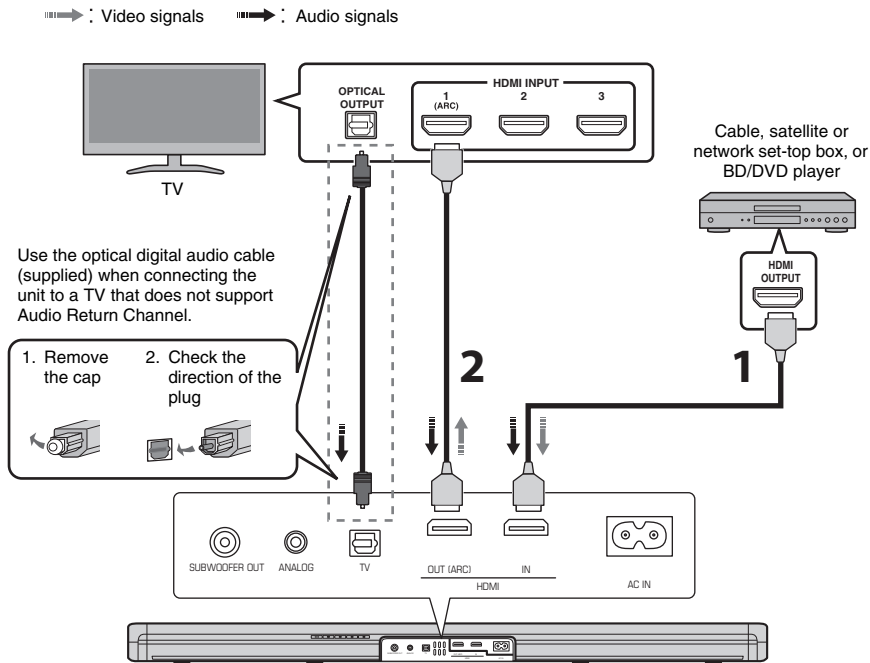

1 HDMI cable (optional)

The digital audio/video signals from the set-top box or BD/DVD player are input to this unit.

2 HDMI cable (optional)

Digital video from the set-top box or BD/DVD player is displayed on the TV.

NOTE

- Use a 19-pin HDMI cable with the HDMI logo printed on it. A cable with a maximum length of 5 m (16 ft) is recommended to prevent degradation of signal quality. For playback of 3D and 4K video content, use a high-speed HDMI cable.
- This unit supports HDCP version 2.2, a copy protection technology. For playback of 4K video, connect the unit to the HDMI input jack (one compatible with HDCP 2.2) on an HDCP 2.2-compliant TV, and to the HDMI output jack on a HDCP 2.2-compliant BD/DVD player.

HINT

Audio Return Channel (ARC) supported TV

- Connect an HDMI cable to the audio return channel supported jack (the jack with "ARC" indicated) on TV.
- Once the HDMI control function has been activated, video and audio content from playback devices can be output from the TV even when this unit is off (HDMI signal pass-through).
- Enable the HDMI control function of this unit to activate the Audio Return Channel (ARC) (p. 26).

What is Audio Return Channel (ARC)?

In order for the unit to play audio from a TV, the TV must usually be connected to the unit via an audio cable as well as an HDMI cable. If, however, the TV supports Audio Return Channel (ARC), TV audio signals can be input to the unit via the HDMI cable that outputs video signals from the unit to the TV.

2 Connecting a game console via the analog jack

Connect an external device, such as a game console or TV that does not have an optical digital audio output, to the ANALOG input jack of the unit.

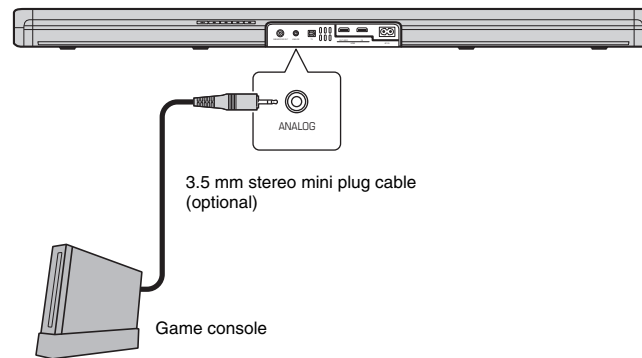

NOTE

- When the ANALOG key on the remote control is pressed, the input source switches to ANALOG, and sound from the device is output via this unit.
- If volume can be adjusted on the device connected to the unit's ANALOG input jack, set that device's volume to the same level as that of other devices connected to the unit's HDMI jacks to prevent volume from being louder than expected.

3 Using an external subwoofer

The unit has dual built-in subwoofers; however you can connect an external subwoofer when you want to enhance low frequency sound. Connect a subwoofer to the SUBWOOFER OUT jack of the unit. Sound is output from both the built-in subwoofers and external subwoofer.

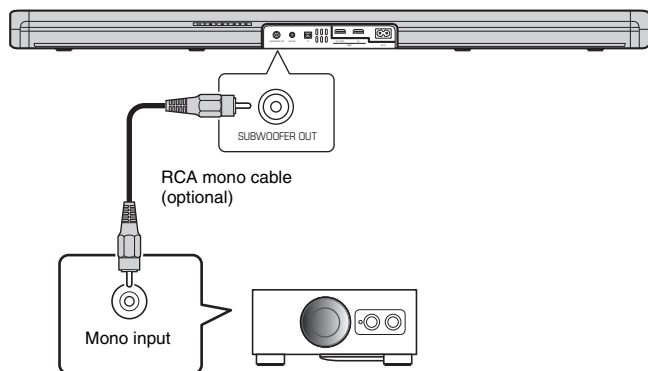

NOTE

- Use an external subwoofer with built-in amplifier.

4 Connecting the power cable

After all connections are complete, connect the supplied power cable to the AC IN jack on the unit and plug the power cable into an AC wall outlet.

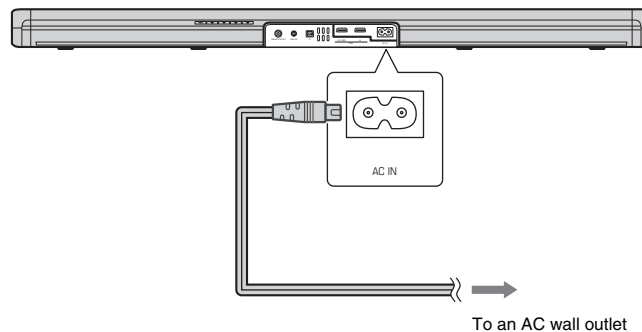

Operations

Remote control signal transmitter

Transmits infrared signals.

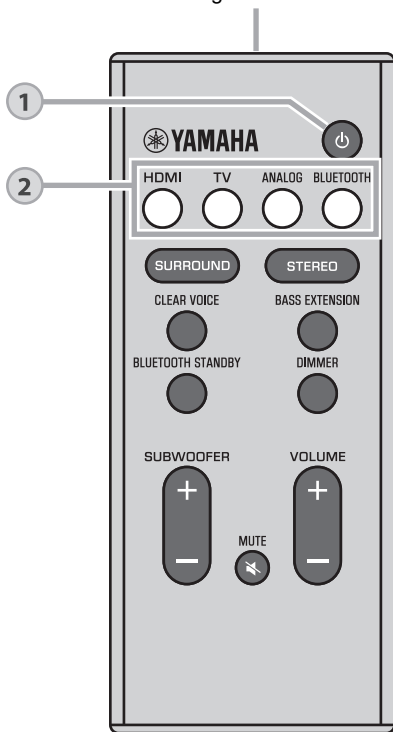

1

⏻ (power) key

Turns on or off the unit.

Turned on



The indicator for the last input source selected glows.

Turned off (*Bluetooth standby function enabled, p. 25*)



2

Input keys

Select an input source to be played back.

HDMISound from a device connected to the HDMI IN jack

TVTV audio or sound from a device connected to the unit's TV input jack

ANALOGSound from a device connected to the ANALOG input jack

BLUETOOTHSound from a *Bluetooth* connected device

The indicator for the selected input source glows.

(Example: when TV is selected)

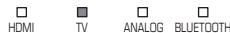

HINT

- To play sound from the device connected to the TV or to watch video from the device, set the TV's input source to the device.
- For playback from a *Bluetooth* device, refer to page 23.

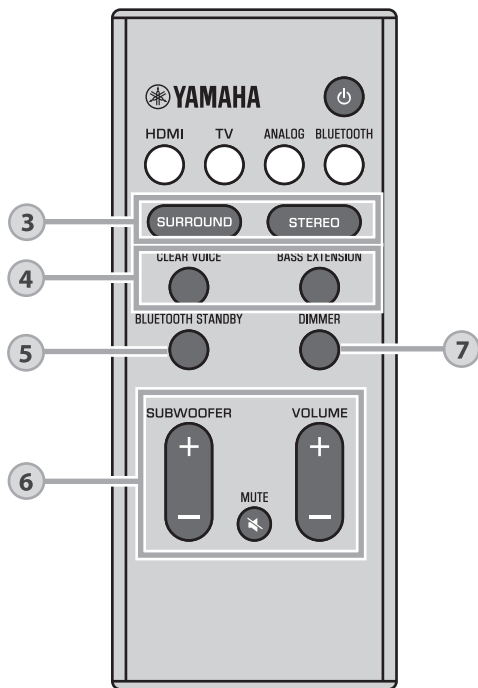

3

SURROUND and STEREO keys

Switch between surround and stereo (2 channel) playback. When surround playback is selected, you can enjoy a realistic sound effect.

SURROUND SURROUND Glows (surround playback)

STEREO SURROUND Off (stereo playback)

HINT

- The DPL indicator glows when 2-channel stereo signal is played in surround. DPL Glows (Dolby ProLogic II)
- The TV Program, Movie, Music, Sports, or Game surround mode can be selected using the HOME THEATER CONTROLLER app (p. 25) installed on a smartphone that supports the *Bluetooth* function.

4

CLEAR VOICE key

Enable/disable the clear voice function. When this function is enabled, human voices such as lines in movies and TV shows, or news and sport commentary, are played clearly.

CLEAR VOICE Glows (enabled) CLEAR VOICE Off (disabled)

BASS EXTENSION key

Enable/disable the bass extension function. When this function is enabled, you can enjoy more powerful sound.

BASS EXTENSION Glows (enabled) BASS EXTENSION Off (disabled)

5**BLUETOOTH STANDBY key**

Hold down the key for more than 3 seconds to enable/disable the *Bluetooth* standby function (p. 25).

6**SUBWOOFER (+/-) keys**

Adjust the volume of the subwoofer.

**MUTE key**

Mute the audio output. Press the key again to unmute.



Flash (on mute)

VOLUME (+/-) keys

Adjust the volume of the unit.

**7****DIMMER key**

Change the brightness of the indicators. Each time the key is pressed, the brightness of the indicators changes as follows.



Dim (default setting) → Off → Bright





Indicators glow brightly just after operation and change to the specified brightness after a few seconds.

Decoder indicator

The unit supports the following audio signals. The color of the indicator identifies the type of audio input signal.

  / DTS Green (Dolby Digital), Red (DTS)

  / DTS Off (PCM/analog signal/no input signal)

Operating the unit by TV's remote control (HDMI control)

The HDMI control function (link function) coordinates operation of a TV and the unit so that the unit can be operated using the TV's remote control.

When a TV is connected to the unit with an HDMI cable (p. 16), the TV's remote control can be used to perform the following operations.

Coordinated functions via the TV remote control

Remote control of TV (Example)

1. Turn on/off

Both the TV and this unit turn on/off at the same time.

2. Switch input sources

- The unit's input source switches accordingly when the TV's input source is switched.

Examples

- When a TV program is selected on the TV, the unit's audio input source is switched to the HDMI OUT (ARC) jack using the ARC function or TV jack.
- When a BD/DVD player is connected to the HDMI IN jack on the unit, the unit's input source switches to HDMI when the BD/DVD player is selected with the TV's remote control.
- The input source can be switched while the unit is off.

3. Switch the audio output device (TV or this unit (amplifier))

4. Adjust volume

This unit's volume can be adjusted when the TV's audio output is set to this unit (amplifier).

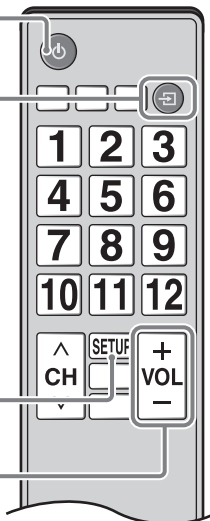

NOTE

- If you are unable to operate the unit with your TV's remote control, see page 26 for more information.

HINT

- Even if your TV supports the HDMI control function, some functions may not be available. For details, refer to documentation supplied with your TV.
- We suggest using devices (TV, BD/DVD player, etc.) from the same manufacturer.

Listening to the sound from a *Bluetooth* device

Audio from a *Bluetooth* device, such as a smartphone or a digital music player, can be played over a wireless connection.

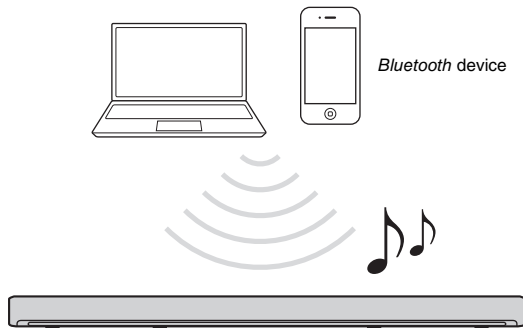

NOTE

- Adjust the volume level of the *Bluetooth* device as required.
- Perform *Bluetooth* connection with the device and unit within 10 m (33 ft) of each other.

HINT

- See documentation supplied with your *Bluetooth* device for more information.

- 1 Press the BLUETOOTH key on the unit's remote control to select *Bluetooth* as the input source.**
The BLUETOOTH indicator on the unit flashes.





If a *Bluetooth* device has been connected before, the unit will connect to the last connected device when the BLUETOOTH key is pressed. Terminate this connection to connect a new device.

- 2 Enable the *Bluetooth* function on the *Bluetooth* device.**

3 Select “YAS-106 Yamaha” in the *Bluetooth* device list on the device.

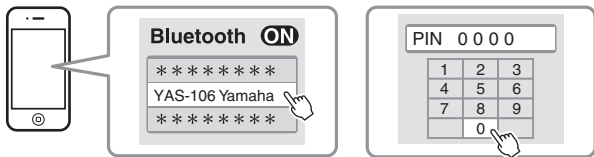
If a passkey (PIN) is required, enter the number “0000”.



When the connection is established, the  indicator or a completion message is displayed on the *Bluetooth* device, and the BLUETOOTH indicator on the unit glows.



4 Play back a song on the *Bluetooth* device.

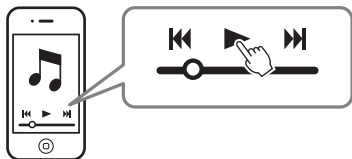

Terminating *Bluetooth* connection

Bluetooth connection is terminated in the following cases. When the *Bluetooth* connection is terminated with the unit turned on, the BLUETOOTH indicator flashes and the unit enters the connection wait status.

- The *Bluetooth* function is turned off on the compatible device.
- The BLUETOOTH key on the unit’s remote control is pressed for more than 3 seconds.
- The unit is turned off.

Using the *Bluetooth* standby function

The *Bluetooth* standby function allows you to turn on or off the unit automatically, linked with the operation of the *Bluetooth* device.

1 With the unit turned on, hold down the **BLUETOOTH STANDBY** key on the unit's remote control for more than 3 seconds.

Holding down the **BLUETOOTH STANDBY** key for 3 seconds switches function status between enabled and disabled.

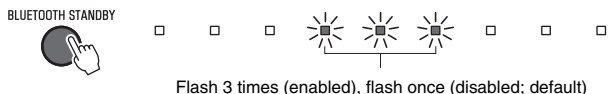

Enabling the *Bluetooth* standby function allows the unit to be turned on or off using a *Bluetooth* device.

Power on interlock function (when the unit is turned off)

When *Bluetooth* connection is made on the device, the unit will turn on and will be ready to play back sound from the device.

Power off interlock function (when the unit is turned on)

The unit will be turned off when *Bluetooth* connection is terminated on a *Bluetooth* device. (Only when **BLUETOOTH** is selected as the input source.)

Using the **HOME THEATER CONTROLLER** app

When the free **HOME THEATER CONTROLLER** app is installed on a *Bluetooth*-compatible smartphone or other device, various operations (basic operation of the unit, selection of a surround mode, adjustment of sound settings, etc.) can be easily performed using the *Bluetooth* device.

NOTE

- To use the app, connect the unit and a *Bluetooth* device via *Bluetooth* connection.
- If the *Bluetooth* standby function is enabled, the unit will be turned on with the *Bluetooth* device.

For details on the “**HOME THEATER CONTROLLER**” app, see the product information on our website.

Settings

Configuring the HDMI control function

Follow the procedure below to enable or disable the unit's HDMI control function. This function is enabled by default.

- 1 Turn off the unit.
- 2 Hold down the HDMI key on the unit's remote control for more than 3 seconds.

Holding down the HDMI key for 3 seconds switches function status between enabled and disabled.

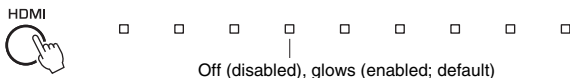

NOTE

- Enable the HDMI control function when connecting a TV that supports Audio Return Channel (ARC) (p. 17), or when using HDMI signal pass-through (p. 17).

If the unit cannot be operated with the TV's remote control

Confirm the settings are properly configured as described below.

- The HDMI control function of this unit is enabled.
- The HDMI control function is enabled on the TV.

Examples of TV settings

- From the setup menu on your TV, select "Link setting" → "HDMI control setting", then set a setting such as "HDMI control function" to "ON".
- Set audio output to any option other than TV.

If the unit cannot be operated with the TV's remote control even after the settings described above have been applied correctly:

- Turn off this unit and the TV, and then turn them back on again.
- Disconnect the power cable of the unit and external devices connected to the unit via HDMI cable. Plug them in again after about 30 seconds.

Configuring HDMI audio output

Specify whether HDMI audio input signal will be played from the unit or the TV.

NOTE

- This setting can only be configured when the HDMI control function is disabled.

The unit (default)	Play HDMI audio input signal from the unit.
TV	Play HDMI audio input signal from the TV connected to the HDMI OUT (ARC) jack on the unit. The unit cannot be used to adjust volume. Use TV controls to adjust volume.

- 1 Turn off the unit.
- 2 Hold down the SURROUND key on the remote control for more than 3 seconds.

Holding down the SURROUND key for 3 seconds switches audio output between this unit and the TV.

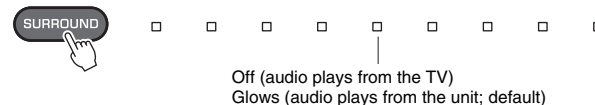

HINT

- To configure HDMI audio output with the HDMI control function enabled, select the audio output device configured for the TV connected to this unit.
- HDMI video signals input to the HDMI IN jack of this unit are always output from the HDMI OUT (ARC) jack of this unit.

Enabling/disabling the auto power standby function

Enabling the auto power standby function prevents the unit from remaining on when not in use.

NOTE

- When the auto power standby function is enabled, the unit automatically turns off in any of the following situations.
 - No operations for 8 hours
 - No audio input and no operations for 20 minutes when BLUETOOTH or HDMI is selected as the input source.

1 Turn off the unit.

2 Hold down the key and press the key on the unit.

The auto power standby function is enabled or disabled, and the unit turns on. For several seconds immediately after the unit is turned on, the indicator shows auto power standby function status.

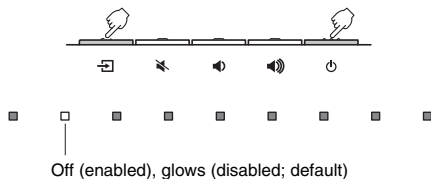

Initializing the unit

Follow the procedure below to initialize the unit.

1 Turn off the unit.

2 Hold down the and keys on the unit at the same time until all indicators flash.

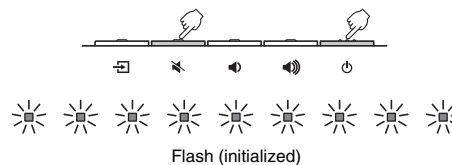

Troubleshooting

Refer to the table below when the unit does not function properly. If the problem you are experiencing is not listed below or if the instructions below do not help, turn off the unit, disconnect the power cable, and contact the nearest authorized Yamaha dealer or service center.

First, check the following:

- ① The power cables of the unit, TV and playback devices (such as BD/DVD players) are connected to AC wall outlets securely.
- ② The unit, TV and playback devices (such as BD/DVD players) are turned on.
- ③ The connectors of each cable are securely inserted into jacks on each device.

Power and system

Problem	Cause	Remedy
The power turns off suddenly.	When the auto power standby function is enabled, the unit automatically turns off in any of the following situations: – No operations have been performed for 8 hours – BLUETOOTH or HDMI is selected as the input source, but no audio has been input to the unit or no operations have been performed with the unit for more than 20 minutes.	Turn on the unit again. If the auto power standby function is not used, disable the function (p. 27).
	The protection circuitry has been activated. (The DD / DTS indicator flashes.)	After confirming that all connections are made properly, turn on the unit again. If the power still turns off frequently, unplug the power cable from the AC wall outlet and contact the nearest authorized Yamaha dealer or service center.
	The <i>Bluetooth</i> connection was terminated by a <i>Bluetooth</i> device with the unit's <i>Bluetooth</i> standby function enabled.	Disable the <i>Bluetooth</i> standby function (p. 25).
The power cannot be turned on.	The protection circuitry has been activated three times consecutively. (If you try to turn on the power in this condition, the DD / DTS indicator will flash.)	To protect the product, the power cannot be turned on. Unplug the power cable from the AC wall outlet and contact the nearest authorized Yamaha dealer or service center.
All indicators go out although the unit is turned on (it may seem that the unit is turned off).	The unit is configured so that indicators do not glow or flash unless the unit is being operated.	Use the DIMMER key to select the desired brightness (p. 21).

Problem	Cause	Remedy
The unit does not function correctly.	The internal microcomputer is frozen, due to an external electric shock (such as lightning or excessive static electricity) or to a drop in the power supply voltage.	Hold down the  key on the unit for more than 10 seconds to turn on the unit. (If the problem persists, unplug the power cable from the AC wall outlet and plug it again.)
The unit turns on by itself.	Another <i>Bluetooth</i> device is being operated nearby.	Terminate <i>Bluetooth</i> connection with the unit (p. 24).
The TV's 3D glasses do not work.	The unit is blocking the TV's 3D glasses transmitter.	Confirm the position of the TV's 3D glasses transmitter, and position the unit so that it does not obstruct the transmitter.
The unit cannot be operated with the HOME THEATER CONTROLLER app. (The screen on the <i>Bluetooth</i> device will not exit the app's demo mode.)	The <i>Bluetooth</i> device on which the app has been installed is not connected to the unit.	Establish a <i>Bluetooth</i> connection between the <i>Bluetooth</i> device and the unit to use the app (p. 23).

Audio

Problem	Cause	Remedy
No sound.	Another input source is selected.	Select an appropriate input source (p. 19).
	The mute function is activated.	Cancel the mute function (p. 21).
	The volume is too low.	Turn up the volume (p. 21).
	The power cable of the unit is not connected properly.	Make sure that the power cable of the unit is connected to an AC wall outlet securely (p. 18).
	Input jacks on a playback device are connected.	Connect the input jack on the unit and the output jack on the playback device.
	Signals that the unit cannot play back are being input.	Change the digital audio output setting on the playback device to PCM, Dolby Digital or DTS.
	The unit is configured so that HDMI audio input signals are output from the TV.	Configure the unit so that HDMI audio input signals are output from the unit (p. 26)
	The HDMI control function is disabled.	When connecting a TV that supports ARC (Audio Return Channel) to the unit using an HDMI cable only, enable the HDMI control function (p. 26). To output audio signals from this unit with the HDMI control function disabled, connect the TV's audio output jack to this unit's TV input jack (optical digital) via the optical digital audio cable (p. 16).
Sound from an HDMI control-enabled TV is set for output from the TV's built-in speakers.	Use the TV's HDMI settings to set audio output to any option other than the TV's built-in speakers.	
No sound is coming from the subwoofer.	The volume of the subwoofer is too low.	Turn up the volume of the subwoofer (p. 21).
	The playback source does not contain low-frequency signals.	Play back a sound source containing low-frequency signals, and confirm that the sound is output from the subwoofer.
The volume decreases when the unit is turned on.	The automatic volume adjustment function is activated. To prevent excessive loudness, the unit automatically controls its volume within a certain level when the unit is turned on.	Turn up the volume as required (p. 21).

Problem	Cause	Remedy
No surround effect.	Stereo playback is selected.	Select surround playback (p. 20).
	The volume is too low.	Turn up the volume (p. 21).
	The TV or playback device is set to output 2 channel audio (such as PCM) only.	Change the digital audio output setting on the TV or playback device to BitStream.
	Sound is also heard from the TV built-in speakers.	Set the TV volume to minimum (p. 22).
	The listening position is too close to the unit.	The listening position should be at some distance from the unit.
Noise is heard.	The unit is too close to another digital or high-frequency device.	Move those devices away from the unit.
Video is not displayed on TV screen.	The HDMI cable is not securely connected.	Connect the HDMI cable properly (p. 16).
When the unit is turned off, video and/or audio from a playback device are not output to the TV.	The HDMI control function is disabled.	Enable the HDMI control function (p. 26)

Remote control

Problem	Cause	Remedy
The unit cannot be operated using the remote control.	The unit is out of the operating range.	Use the remote control within the operating range (p. 8).
	The batteries are weak.	Replace with new batteries (p. 9).
	The remote control sensor of the unit is exposed to direct sunlight or strong lighting.	Adjust the lighting angle, or reposition the unit.
The TV cannot be operated using the TV's remote control.	The unit is blocking the TV's remote control sensor.	Position the unit so that it does not obstruct the TV's remote control sensor.

Bluetooth

Problem	Cause	Remedy
Unable to connect the unit to a Bluetooth device.	<i>Bluetooth</i> is not selected as the input source.	Select <i>Bluetooth</i> as the input source (p. 23).
	The device does not support A2DP.	Connect to a <i>Bluetooth</i> audio device that supports A2DP.
	A <i>Bluetooth</i> adaptor, etc. that you want to connect to the unit has a password other than "0000".	Use a <i>Bluetooth</i> adaptor, etc. whose password is "0000".
	The unit and device are too far apart.	Position the <i>Bluetooth</i> device so that it is less than 10 m (33 ft) from this unit and connect the device to this unit.
	There is a device (microwave oven, wireless LAN, etc.) outputs signals in the 2.4 GHz frequency band nearby.	Move this unit away from the device that is emitting radio frequency signals.
	Another <i>Bluetooth</i> device is connected.	Terminate the current <i>Bluetooth</i> connection, and connect to the device from which audio should be received.
	As more than nine devices have been connected, information for the oldest connection has been deleted.	Connect to the device again. The unit is can connect to up to eight <i>Bluetooth</i> devices for receiving audio. If a new device is successfully connected to the unit after eight other devices have already been connected, the device with the earliest connection date will have been deleted to make room for the new device.
No sound is heard or the sound is intermittent via the unit.	The <i>Bluetooth</i> connection of the unit with the device is disconnected.	Perform <i>Bluetooth</i> connection operations again (p. 23).
	<i>Bluetooth</i> is not selected as the input source.	Select <i>Bluetooth</i> as the input source (p. 23).
	The unit and device are too far apart.	Move the <i>Bluetooth</i> device so that it is less than 10 m (33 ft) from this unit.
	There is a device (microwave oven, wireless LAN, etc.) outputs signals in the 2.4 GHz frequency band nearby.	Move this unit away from the device that is emitting radio frequency signal.
	The device is not set to send <i>Bluetooth</i> audio signals to the unit.	Check that the <i>Bluetooth</i> function of the device is set properly.
	Playback on the device has not been performed.	Perform playback on the device.
The device's volume is set to minimum.	Turn up the volume level on the device.	

Specifications

Item		Specifications
Amplifier Section	Maximum Rated Output Power	Front L/R 30 W x 2 ch
		Subwoofer 60 W
Front L/R Section	Type	Acoustic suspension type
	Driver	5.5 cm (2-1/8") cone non-magnetic shielding type x 2
	Frequency Response	160 Hz to 23 kHz
	Impedance	6Ω
Tweeter Section	Type	—
	Driver	25 mm (1") dome magnetic shielding type x 2
	Frequency Response	4 kHz to 23 kHz
	Impedance	6Ω
Subwoofer Section	Type	Bass reflex type
	Driver	7.5 cm (3") cone non-magnetic shielding type x 2
	Frequency Response	60 Hz to 160 Hz
	Impedance	3Ω (6Ω x 2)
Decoder	Supported audio signal	PCM (up to 5.1ch) Dolby Digital (up to 5.1ch) DTS Digital Surround (up to 5.1ch)
Input Jacks	HDMI	1 (HDMI IN)
	Digital (Optical)	1 (TV)
	Analog (3.5 mm stereo mini)	1 (ANALOG)
Output Jack	HDMI	1 (HDMI OUT (ARC))
	Analog (RCA/monaural)	1 (SUBWOOFER OUT)

Item		Specifications
Bluetooth	Bluetooth version	Ver. 2.1 +EDR
	Supported protocols	Receiving: A2DP, SPP
	Supported codecs	Receiving: SBC, MPEG-4 AAC
	Wireless output	Bluetooth Class 2
	Range (line-of-sight)	Approx. 10 m (33 ft)
	Supported content protection method	SCMS-T
General	Power Supply	U.S.A. and Canada models: AC 120 V, 60Hz Taiwan model: AC 110 - 120 V, 50/60Hz China model: AC 220V, 50Hz Other models: AC 220 - 240 V, 50/60Hz
	Power Consumption	27 W
	Standby Power Consumption	Australia, China, Korea, and Asia models HDMI Control Off, Bluetooth Standby Off: 0.4 W HDMI Control On, Bluetooth Standby Off: 1.9 W HDMI Control Off, Bluetooth Standby On: 0.4 W Other models HDMI Control Off, Bluetooth Standby Off: 0.2 W HDMI Control On, Bluetooth Standby Off: 1.8 W HDMI Control Off, Bluetooth Standby On: 0.2 W
	Dimensions (W x H x D)	890 x 53 x 131 mm (35" x 2-1/8" x 5-1/8") (installing the unit in front of a TV, etc.) 890 x 131 x 62 mm (35" x 5-1/8" x 2-1/2") (mounting the unit on a wall, with spacers)
	Weight	3.2 kg (7.1 lbs)

HDMI signal

• Audio signals

Audio signal types	Audio signal formats	Compatible media
2ch Linear PCM	2ch, 32–96 kHz, 16/20/24 bit	CD, DVD-Video, DVD-Audio, etc.
Multi-ch Linear PCM	6ch, 32–96 kHz, 16/20/24 bit	DVD-Audio, Blu-ray disc, HD DVD, etc.
Bitstream	Dolby Digital, DTS	DVD-Video, etc.

HINT

- Refer to documentation supplied with the playback device, and set the device appropriately.
- When CPPM copy-protected DVD-Audio is played back, video and audio signals may not be output depending on the type of the DVD player.
- This unit is not compatible with HDCP-incompatible HDMI or DVI devices. Refer to documentation supplied with the HDMI or DVI device for HDCP compatibility.
- To decode audio bitstream signals on this unit, set the input source device appropriately so that the device outputs the bitstream audio signals directly (does not decode the bitstream signals on the device). Refer to documentation supplied with the device for details.

• Video signals

This unit is compatible with the following video signals.

- Deep Color
- x.v.Color
- 3D video signal
- High Dynamic Range (HDR) video

This unit is compatible with the following resolutions.

- VGA
 - 720p/60 Hz, 50 Hz
- 480i/60 Hz
 - 1080i/60 Hz, 50 Hz
- 480p/60 Hz
 - 1080p/60 Hz, 50 Hz, 30 Hz, 25 Hz, 24 Hz
- 576i/50 Hz
 - 4K/60 Hz, 50 Hz, 30 Hz, 25 Hz, 24 Hz
- 576p/50 Hz

HINT

- The resolution of transmitted video signal varies according to specifications of the TV connected to this unit.

Digital audio signal

• Optical

Audio signal types	Audio signal formats	Compatible media
2ch Linear PCM	2ch, 32–48 kHz, 16/20/24 bit	CD, DVD-Video, DVD-Audio, etc.
Bitstream	Dolby Digital, DTS	DVD-Video, etc.

• HDMI (ARC)

Audio signal types	Audio signal formats	Compatible media
2ch Linear PCM	2ch, 32–96 kHz, 16/20/24 bit	TV
Bitstream	Dolby Digital, DTS	TV

The contents of this manual apply to the latest specifications as of the publishing date.

To obtain the latest manual, access the Yamaha website then download the manual file.



The *Bluetooth*[®] word mark and logos are registered trademarks owned by *Bluetooth* SIG, Inc. and any use of such marks by Yamaha Corporation is under license.



Manufactured under license from Dolby Laboratories.

Dolby, Dolby Audio, Pro Logic, and the double-D symbol are trademarks of Dolby Laboratories.



For DTS patents, see <http://patents.dts.com>. Manufactured under license from DTS Licensing Limited.

DTS, the Symbol, & DTS and the Symbol together are registered trademarks, and DTS Digital Surround is a trademark of DTS, Inc. © DTS, Inc. All Rights Reserved.



The terms HDMI, the HDMI Logo, and High-Definition Multimedia Interface are trademarks or registered trademarks of HDMI Licensing LLC in the United States and other countries.

Blu-ray

"Blu-ray Disc[™]", "Blu-ray[™]", and the logos are trademarks of the Blue-ray Disc Association.



"Made for iPod," "Made for iPhone," and "Made for iPad" mean that an electronic accessory has been designed to connect specifically to iPod, iPhone, or iPad, respectively, and has been certified by the developer to meet Apple performance standards. Apple is not responsible for the operation of this device or its compliance with safety and regulatory standards. Please note that the use of this accessory with iPod, iPhone, or iPad may affect wireless performance.

Bluetooth

Bluetooth is a technology for wireless communication employing the 2.4 GHz frequency band, which can be used without a license.

Handling *Bluetooth* communications

- The 2.4 GHz band used by *Bluetooth* compatible devices is a radio band shared by many types of equipment. While *Bluetooth* compatible devices use a technology minimizing the influence of other components using the same radio band, such influence may reduce the speed or distance of communications and in some cases interrupt communications.
- The speed of signal transfer and the distance at which communications is possible differs according to the distance between the communicating devices, the presence of obstacles, radio wave conditions and type of equipment.
- Yamaha does not guarantee all wireless connections between this unit and devices compatible with *Bluetooth* function.

Yamaha Global Site
<http://www.yamaha.com/>

Yamaha Downloads
<http://download.yamaha.com/>

Manual Development Group
© 2016 Yamaha Corporation

Published 06/2016 KS-B0
Printed in China

YAS-106/UA